

Momento

Warm comfort

Product Catalog

September February 2023

1 800 463-7043
www.momentoconfort.com



Contact Us

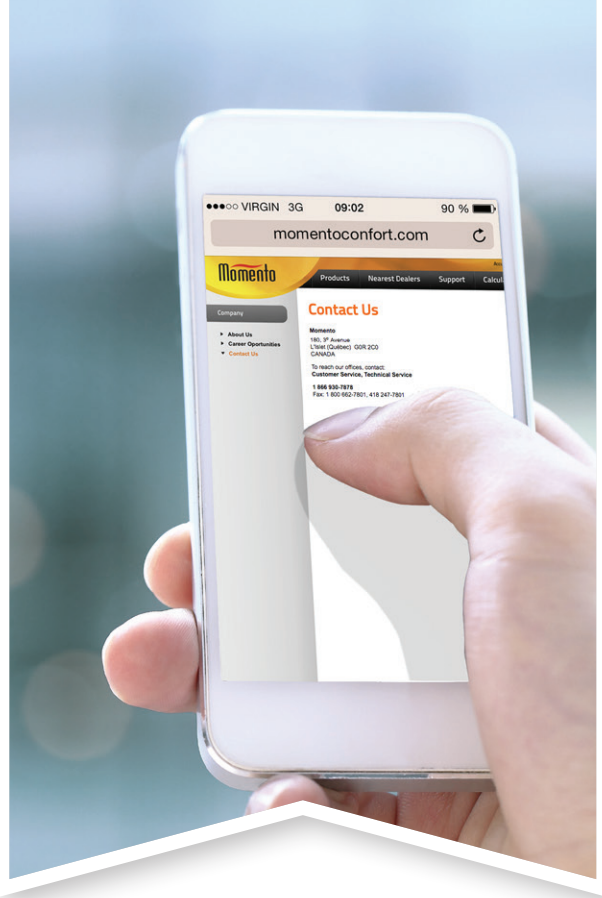

Momento

180, 3^e Avenue, L'Islet (Québec) G0R 2C0

TF 1 800 463-7043

www.momentoconfort.com



















OFFICE HOURS:
From Monday to Friday
8:00 a.m. to 4:30 p.m. (EST)

NEW!



Floor Heating Calculator Available Online

Table of Contents

Floor Heating Systems		
	Free Cable System <u>FOR MEMBRANE</u> (CAR)	4
	Free Cable System <u>FOR INSTALLATION WITH STRAPPING</u> (CAR-P)	6
	Uncoupling Self-Adhesive Membrane	8
Controls for Floor Heating System		
	Non Programmable Electronic Thermostat (OTH3600-GA)	9
	Programmable Electronic Thermostat (OTH3600P-GA)	9
	Slave Unit (TR1310)	9
Smart Controls for Floor Heating System		
	Smart Thermostat - Zigbee (OTH3600-GA-ZB)	10
	Smart Gateway - Zigbee (GT130)	10
Accessories for Floor Heating System		
	Accessories for Floor Heating System	11
Floor Heating System Warranty		12
Wall-Mounted Heating Units		
	Calora - European-Style Convector	13
	Espresso - European-Style Wall Heater	15
	Morelli - Convection and Forced-Air Wall Heater	17
	Viento - Compact Wall Heater	19
Electronic Thermostats for Heating Units		
	Programmable Electronic Thermostats (OTH3000P-A, OTH4000P-A)	21
	Non Programmable Electronic Thermostats (OTH3000-A, OTH4000-A)	21
Smart Controls for Heating Units		
	Smart Thermostat - Zigbee (OTH4000-ZB)	22
	Smart Gateway - Zigbee (GT130)	22
Heating Units Warranty		23
Terms and Conditions		24
Account Opening		25

Momento reserves the right to make any changes to this pamphlet or its products at any time without notice.



Free Cable System FOR MEMBRANE (CAR)



The Momento floor heating systems provide comfort and well-being through radiant heating. They produce enveloping heat that is also clean, cost-effective, uniform, and constant.

Features

Voltage

- 120V, 240/208V, 1-phase.

Cold lead length

- 10' (3 m).

Construction

- Heating cable made of a twin conductor, compatible with uncoupling membrane systems.

Watt density

- 9.6W/sq. ft. (103W/sq. m), 3 3/4" (95 mm) spacing.
- 10W/sq. ft. (108W/sq. m), 3 5/8" (92 mm) spacing.

Control

- Two types of control method possible (see instruction manual for details):
 - Surface heating control with electronic thermostat equipped with a floor sensor.
 - Ambient heating control with electronic thermostat equipped with a built-in ambient sensor and a floor sensor.

Note: A ground fault circuit interrupter (GFCI) must be used with this heating device unless exempted by the applicable national and/or local electrical code for the area of installation.

Included materials

- 15' (4.6 m) floor sensor.
- Measurements table label (to be placed in electrical panel).

Installation

- **Never cut or shorten the heating cable.**
- For indoor applications only.
- On concrete slab or plywood subfloor.
- On uncoupling membrane sold in option.

For heating cable installation on uncoupling membrane systems, consult the membrane manufacturer's instructions to ensure that it is compatible with the use of heating cables.

Warranty

- 25-year warranty on the heating cable.

Application

- Kitchen, bathroom, entrance way, family room, living room.

Included:



10' (3 m)
floor sensor

Optional:

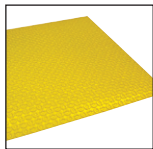

Uncoupling
membrane
in sheet

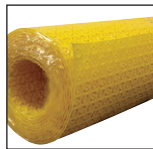

Uncoupling
membrane
in roll

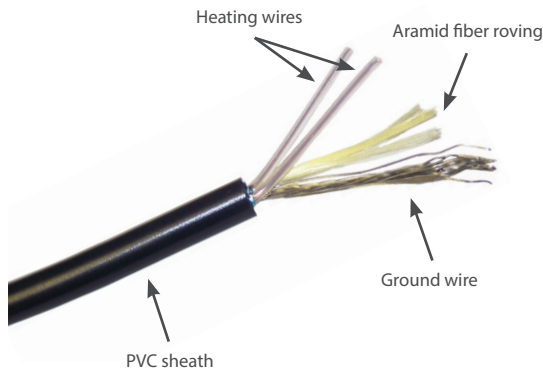

Free Cable System FOR MEMBRANE (CAR)

240/208V Models

Product # 240/208V	Price	Covered Surface Depending on Spacing ¹				Watts	Amp.	Cable Length	
		3 5/8" (92 mm) ²		3 3/4" (95 mm)				ft.	m
		10W/sq. ft.	108W/sq. m.	9.6W/sq. ft.	103W/sq. m.				
0170CAR240	182.00	18.5	1.7	19.0	1.8	170	0.70	61	18.59
0240CAR240	218.00	24.0	2.2	25.0	2.3	240	1.00	80	24.38
0300CAR240	246.00	30.5	2.8	31.5	2.9	300	1.25	101	30.78
0360CAR240	258.00	36.5	3.4	37.5	3.5	360	1.50	120	36.58
0420CAR240	273.00	42.5	4.0	44.0	4.1	420	1.75	141	42.98
0475CAR240	285.00	48.5	4.5	50.0	4.6	475	1.98	160	48.77
0600CAR240	336.00	60.5	5.6	62.5	5.8	600	2.50	200	60.96
0720CAR240	375.00	72.5	6.7	75.0	7.0	720	3.00	240	73.15
0840CAR240	390.00	84.5	7.9	87.5	8.1	840	3.50	280	85.34
0960CAR240	453.00	96.5	9.0	100.0	9.3	960	4.00	320	97.54
1080CAR240	467.00	109.0	10.1	112.5	10.5	1080	4.50	360	109.73
1200CAR240	520.00	121.0	11.2	125.0	11.6	1200	5.00	400	121.92
1440CAR240	545.00	145.0	13.5	150.0	13.9	1440	6.00	480	146.30
1600CAR240	650.00	169.0	15.7	175.0	16.3	1600	6.67	560	170.69
1920CAR240	754.00	193.5	18.0	200.0	18.6	1920	8.00	640	195.07
2280CAR240	845.00	229.5	21.3	237.5	22.1	2280	9.5	760	231.65
2640CAR240	979.00	266.0	24.7	275.0	25.5	2640	11.00	880	268.22
2900CAR240	1084.00	292.5	27.2	302.5	28.1	2900	12.08	968	295.04
3000CAR240	1125.00	302.0	28.1	312.5	29.0	3000	12.50	1000	304.80
3360CAR240	1173.00	338.5	31.4	350	32.5	3360	14	1120	341.38

120V Models

Product # 120V	Price	Covered Surface Depending on Spacing ¹				Watts	Amp.	Cable Length	
		3 5/8" (92 mm) ²		3 3/4" (95 mm)				ft.	m
		10W/sq. ft.	108W/sq. m.	9.6W/sq. ft.	103W/sq. m.				
0085CAR120	129.00	9.5	0.9	10.0	0.9	85	0.70	32	9.75
0120CAR120	142.00	12.0	1.1	12.5	1.2	120	1.00	40	12.19
0150CAR120	167.00	16.0	1.5	16.5	1.5	150	1.25	53	16.15
0170CAR120	182.00	18.5	1.7	19.0	1.8	170	1.42	61	18.59
0240CAR120	218.00	24.0	2.2	25.0	2.3	240	2.00	80	24.38
0300CAR120	246.00	30.5	2.8	31.5	2.9	300	2.50	101	30.78
0360CAR120	258.00	36.5	3.4	37.5	3.5	360	3.00	120	36.58
0420CAR120	273.00	42.5	4.0	44.0	4.1	420	3.50	141	42.98
0475CAR120	285.00	48.5	4.5	50.0	4.6	475	3.96	160	48.77
0600CAR120	336.00	60.5	5.6	62.5	5.8	600	5.00	200	60.96
0720CAR120	375.00	72.5	6.7	75.0	7.0	720	6.00	240	73.15
0840CAR120	390.00	84.5	7.9	87.5	8.1	840	7.00	280	85.34
0960CAR120	453.00	96.5	9.0	100.0	9.3	960	8.00	320	97.54
1140CAR120	554.00	115	10.66	119	11.03	1140	9.5	380	115.82
1320CAR120	605.00	133	12.35	137.5	12.77	1320	11	440	134.11
1450CAR120	624.00	145	13.5	150	13.9	1450	12	480	146.30
1500CAR120	642.00	151	14	156.5	14.5	1500	12.5	500	152.40
1680CAR120	680.00	169.5	15.7	175	16.3	1680	14	560	170.69

¹ Does not represent the surface of the room but rather the surface covered by the floor heating system, excluding fixtures and other spaces to consider.
Surface area covered may vary depending on the model of membrane chosen.

² Spacing with the NADCM membrane when the cable is installed with 3 spacing castellations.

208V = 75% of wattage at 240V.

15' (4.6 m) floor sensor and 10' (3 m) cold lead included.

Options

Product #	Unit Price	Description
NADCM-M-80	30.00	Fleeceback uncoupling membrane in sheet, 2' 6-5/16" X 3' 3", 8.16 sq. ft., sold in box of 10 sheets
NADCM-M-150	505.00	Fleeceback uncoupling membrane in roll, 46' 9" x 3' 3", 150 sq. ft.
NADCM-S-80	41.00	Uncoupling self-adhesive membrane in sheet, 2' 6-5/16" X 3' 3", 8.16 sq. ft., sold in box of 10 sheets
NADCM-S-150	647.00	Uncoupling self-adhesive membrane in roll, 46' 9" x 3' 3", 150 sq. ft.

For heating cable installation on uncoupling membrane systems, consult the membrane manufacturer's instructions to ensure that it is compatible with the use of heating cables.



Free Cable System FOR INSTALLATION WITH STRAPPING (CAR-P)



The Momento floor heating systems provide comfort and well-being through radiant heating. They produce enveloping heat that is also clean, cost-effective, uniform, and constant.

Features

Voltage

- 120V, 240/208V, 1-phase.

Cold lead length

- 10' (3 m).

Construction

- Heating cable made of a twin conductor.

Watt density

- 12W/sq. ft. (130W/sq. m), 3" (76 mm) spacing.
- 9W/sq. ft. (100W/sq. m), 4" (102 mm) spacing.

Control

- Two types of control method possible (see instruction manual for details):
 - Surface heating control with electronic thermostat equipped with a floor sensor.
 - Ambient heating control with electronic thermostat equipped with a built-in ambient sensor and a floor sensor.

Note: A ground fault circuit interrupter (GFCI) must be used with this heating device unless exempted by the applicable national and/or local electrical code for the area of installation.

Included materials

- Plastic installation strapping.
- 15' (4.6 m) floor sensor.
- Measurements table label (to be placed in electrical panel).

Installation

- **Never cut or shorten the heating cable.**
- For indoor applications only.
- On concrete slab or plywood subfloor.

Warranty

- 25-year warranty on the heating cable.

Application

- Kitchen, bathroom, entrance way, family room, living room.

Included:



Installation Strapping



10' (3 m) floor sensor

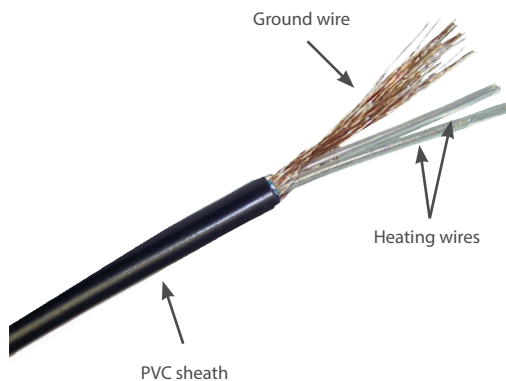

Free Cable System FOR INSTALLATION WITH STRAPPING (CAR-P)

240/208V Models

Product # ¹ 240/208V	Price	Covered Surface Depending on Spacing ²				Watts	Amp.	Cable Length	
		3" (76 mm)		4" (102 mm)				ft.	m
		12W/sq. ft.	130W/sq. m	9W/sq. ft.	100W/sq. m				
0170CAR240-P	187.00	15.0	1.4	20.0	1.9	170	0.70	61	18.59
0240CAR240-P	227.00	20.0	1.9	27.0	2.5	240	1.00	80	24.38
0300CAR240-P	254.00	25.0	2.3	33.0	3.1	300	1.25	101	30.78
0360CAR240-P	266.00	30.0	2.8	40.0	3.7	360	1.50	120	36.58
0420CAR240-P	280.00	35.0	3.3	47.0	4.3	420	1.75	141	42.98
0475CAR240-P	294.00	40.0	3.7	53.0	5.0	475	1.97	160	48.76
0600CAR240-P	348.00	50.0	4.6	67.0	6.2	600	2.50	200	60.96
0720CAR240-P	389.00	60.0	5.6	80.0	7.4	720	3.00	240	73.15
0840CAR240-P	401.00	70.0	6.5	93.0	8.7	840	3.50	280	85.34
0960CAR240-P	467.00	80.0	7.4	107.0	9.9	960	4.00	320	97.54
1080CAR240-P	483.00	90.0	8.4	120.0	11.2	1080	4.50	360	109.73
1200CAR240-P	536.00	100.0	9.3	133.0	12.4	1200	5.00	400	121.92
1440CAR240-P	563.00	120.0	11.1	160.0	14.9	1440	6.00	480	146.30
1600CAR240-P	670.00	140.0	13.0	187.0	17.4	1600	6.60	560	170.69
1920CAR240-P	776.00	160.0	14.9	213.0	19.8	1920	8.00	640	195.07
2280CAR240-P	896.00	190.0	17.7	253.0	23.6	2280	9.50	760	231.64
2640CAR240-P	979.00	220.0	20.4	293.0	27.2	2640	11.00	880	268.22
2900CAR240-P	1084.00	242.0	22.5	323.0	30.0	2900	12.08	968	295.04
3000CAR240-P	1125.00	250.0	23.2	333.0	30.9	3000	12.50	1000	304.80
3360CAR240-P	1230.00	280.0	26.0	374.0	34.7	3360	14.00	1120	341.38

120V Models

Product # ¹ 120V	Price	Covered Surface Depending on Spacing ²				Watts	Amp.	Cable Length	
		3" (76 mm)		4" (102 mm)				ft.	m
		12W/sq. ft.	130W/sq. m	9W/sq. ft.	100W/sq. m				
0085CAR120-P	132.00	8.0	0.7	11.0	1.0	85	0.70	32	9.75
0120CAR120-P	147.00	10.0	0.9	13.0	1.2	120	1.00	40	12.19
0150CAR120-P	172.00	13.0	1.2	17.0	1.6	150	1.25	53	16.15
0170CAR120-P	187.00	15.0	1.4	20.0	1.9	170	1.41	61	18.59
0240CAR120-P	227.00	20.0	1.9	27.0	2.5	240	2.00	80	24.38
0300CAR120-P	254.00	25.0	2.3	33.0	3.1	300	2.50	101	30.78
0360CAR120-P	266.00	30.0	2.8	40.0	3.7	360	3.00	120	36.58
0420CAR120-P	280.00	35.0	3.3	47.0	4.3	420	3.50	141	42.98
0475CAR120-P	294.00	40.0	3.7	53.0	5.0	475	3.95	160	48.76
0600CAR120-P	348.00	50.0	4.6	67.0	6.2	600	5.00	200	60.96
0720CAR120-P	389.00	60.0	5.6	80.0	7.4	720	6.00	240	73.15
0840CAR120-P	401.00	70.0	6.5	93.0	8.7	840	7.00	280	85.34
0960CAR120-P	467.00	80.0	7.4	107.0	9.9	960	8.00	320	97.54
1140CAR120-P	589.00	95.0	8.8	127.0	11.7	1140	9.50	380	115.82
1320CAR120-P	644.00	110.0	10.2	147.0	13.6	1320	11.00	440	134.11
1450CAR120-P	664.00	120.0	11.1	160.0	14.8	1450	12.08	480	146.30
1500CAR120-P	683.00	125.0	11.6	167.0	15.5	1500	12.50	500	152.40
1680CAR120-P	760.00	140.0	13.0	187.0	17.4	1680	14.00	560	170.69

¹ Installation strapping included. The length of plastic strapping included is based on a square room with strapping every 24" (610 mm).

² Does not represent the surface of the room but rather the surface covered by the floor heating system, excluding fixtures and other spaces to consider.

208V = 75% of wattage at 240V.

15' (4.6 m) floor sensor and 10' (3 m) cold lead included.

Uncoupling Membrane

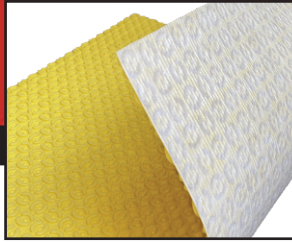
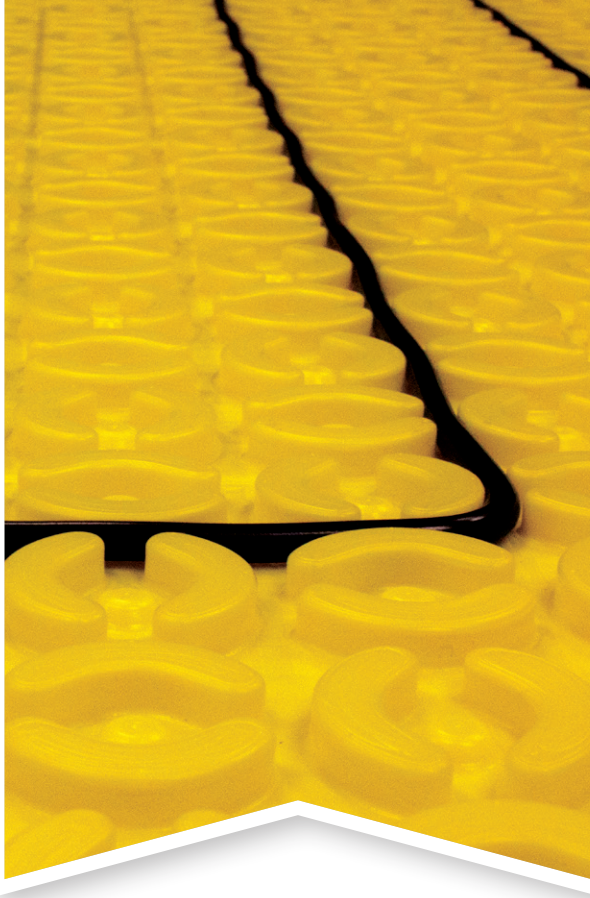

Fleeceback uncoupling membrane available in sheet (NADCM-M-80) or in roll (NADCM-M-150)

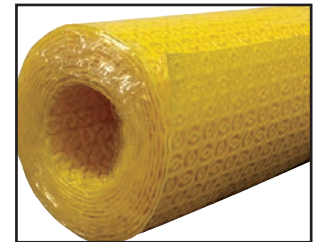
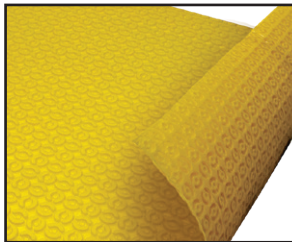

Self-adhesive uncoupling membrane available in sheet (NADCM-S-80) or in roll (NADCM-S-150)

Self-adhesive uncoupling membrane saves time and money during installation because there's no wait time between installing the membrane and laying the cable.

The fleeceback uncoupling membrane provides anti-fracture properties to the subfloor and its installed easily with any type of thin-set mortar.

They are fully compatible with our CAR and CAR-P free cable systems.

Features

- Neutralizes subfloor movement from creating cracks to the floor covering;
- Self-adhesive, no need for thin-set mortar¹;
- Fleeceback, for optimal adhesion to thinset mortar;
- Castellated structure designed for quick and easy installation of cables, North America approved model;
- Optimal heat distribution from the cable to the floor;
- Spacing of 3 5/8" and a density of 10W/sq. ft.

¹ May need the application of a primer.

Models

Product #	Unit Price	Description
NADCM-M-80	30.00	Fleeceback uncoupling membrane in sheet, 2' 6-5/16" X 3' 3", 8.16 sq. ft., sold in box of 10 sheets
NADCM-M-150	505.00	Fleeceback uncoupling membrane in roll, 46' 9" x 3' 3", 150 sq. ft.
NADCM-S-80	41.00	Uncoupling self-adhesive membrane in sheet, 2' 6-5/16" X 3' 3", 8.16 sq. ft., sold in box of 10 sheets
NADCM-S-150	647.00	Uncoupling self-adhesive membrane in roll, 46' 9" x 3' 3", 150 sq. ft.

Controls for Floor Heating System



Compliance with standard
CSA-C828-13

OTH3600-GA Series

Non programmable electronic thermostat

The OTH3600-GA model combines simplicity and elegance with cutting-edge technology. It features limited number of buttons, for easy operation. The backlit display activates when any button is pressed. There are also two regulation modes: one to control ambient temperature and another for floor temperature. This thermostat has a ground fault circuit interrupter (GFCI) to ensure maximum safety.

It also features an auxiliary contact that can be used to control additional heat sources, either by using a slave module for heated floors (TR1310 Series) or a relay and low-voltage transformer for electric heaters.



OTH3600P-GA Series

Programmable electronic thermostat

As well as offering the core modes of the OTH3600-GA, the OTH3600P-GA model can start the heating system at preprogrammed times on different days. You can set specific temperatures for four periods on each day of the week. Lower the temperature at night and when nobody is home to reduce energy costs without affecting your comfort. A "no-freeze" mode is also available for extended periods of absence in a second home or cottage. This thermostat has a ground fault circuit interrupter (GFCI) to ensure maximum safety.

It also features an auxiliary contact that can be used to control additional heat sources, either by using a slave module for heated floors (TR1310 Series) or a relay and low-voltage transformer for electric heaters.



TR1310 Series

Slave Unit

The TR1310 series slave units are specially designed for large floor heating applications exceeding 15 Amps. They drive their own part of the floor and are also equipped with a ground fault circuit interrupter (GFCI). These modules, which are controlled by a main thermostat of the OTH3600 series, require only one thermostat to regulate large areas.



Models

Product #	Price	Description	Volts	Amp.	Protection
OTH3600-GA ¹	160.00	Non programmable electronic thermostat			
OTH3600P-GA ¹	190.00	Programmable electronic thermostat	120/208/240	15	Class A GFCI 5mA ²
TR1310-120-240GA	147.00	Slave unit			

¹ 15' (4.6 m) floor sensor included.

² GFCI: Ground fault circuit interrupter.

Smart Controls for Floor Heating Systems



Compliance with standard
CSA-C828-13



The thermostats have integral ground fault protection (Class A-GFCI), which can detect 5mA of current leakage, and are equipped with a terminal for connecting a floor temperature sensor. They also have a built-in ambient sensor which provides room temperature control and the ability to set a maximum/minimum floor temperature.

They also feature an auxiliary contact that can be used to control additional heat sources, either by using a slave module for heated floors (TR1310 series) or relay and low-voltage transformer for electric heaters.



TH1310WF Series

Smart thermostat - Wi-Fi



The TH1310WF easily integrates with your favorite smart home platform and allows for remote access from your smart phone or tablet using the Neviweb® app. Among other features, it can be programmed to allow individual temperatures up to six periods per day, for each day of the week. Daily and monthly usage can be monitored to help cut down on heating costs.



OTH3600-GA-ZB Series

Smart thermostat - Zigbee

In order to have access to the thermostat functions, you require a GT130 hub and a permanent internet connection. This will allow access to all the features available in the NeviWeb® platform, like be programmed to allow individual temperatures to be set for six periods per day and for each day of the week. Daily and monthly usage can be monitored to help cut down on heating costs.

Zigbee



GT130 Series

Smart Gateway - Zigbee

The GT130 smart gateway provides remote access to all your Neviweb®-compatible products including your Zigbee smart thermostats with the Neviweb® app. The only requirement for the smart gateway is a broadband Internet connection and an open port on a router. Ideal for homes, condos and holiday homes.

Models

Product #	Price	Description	Volts	Amp.	Protection
TH1310WF ¹	250.00	Smart thermostat – Wi-Fi for floor heating system			
OTH3600-GA-ZB ¹	235.00	Smart thermostat – Zigbee for floor heating system	120/208/240	15	Class A GFCI 5mA ²
TR1310-120-240GA	147.00	Slave unit for floor heating system			
GT130	122.00	Smart gateway that provides remote access to the OTH3600-GA-ZB and OTH4000-ZB	-	-	-

¹ 15' (4.6 m) floor sensor included.

² GFCI: Ground fault circuit interrupter.

Use of the Works with Apple badge means that an accessory has been designed to work specifically with the technology identified in the badge and has been certified by the developer to meet Apple performance standards. Apple is not responsible for the operation of this device or its compliance with safety and regulatory standards. HomeKit is a trademark of Apple Inc. Neviweb® is a registered trademark of Sinopé Technologies Inc. in Canada and the United States. Apple and the Apple logo are trademarks of Apple Inc., registered in the U.S. and other countries. App Store is a service mark of Apple Inc., registered in the U.S. and other countries. Google Play and the Google Play logo are trademarks of Google Inc. The Wi-Fi CERTIFIED™ Logo is a certification mark of Wi-Fi Alliance®.

Accessories for Floor Heating Systems



OTM-CC

The electrical fault indicator detects any breakage in the heating cable during installation (open or short circuit).



KIT-CBL-G25

Plastic installation strapping for CAR-P Series.

CAR-P Series cables are sold with installation strapping, but additional installation strapping can be ordered if required.



KIT-SP1

Repair kit for floor heating cable.

Models

Product #	Price	Description
OTM-CC	40.00	Electrical fault indicator
KIT-CBL-G25	35.00	25 ft. (7.6 m) plastic installation strapping for CAR-P Series
KIT-SP1	47.00	Repair kit for floor heating cable

Floor Heating System Warranty

This **Limited Warranty** is offered by Ouellet Canada Inc. (“Ouellet”) to the original user (“Owner”) of CAR and CAR-P series heating cables (the “Product”). This warranty may not be assigned or transferred to a subsequent Owner.

Limited Warranty coverage

Ouellet guarantees that the Product is free of any material or manufacturing defects as part of normal domestic use. The warranty is valid **for 25 years** from the date of purchase by the Owner, which must be established by the Owner’s sales receipt for the Product or by the invoice given to the Owner by the retailer/installer of the Product.

The purchaser must notify Ouellet in writing of any alleged defect with the Product within 30 days of discovering the alleged defect and, where necessary, must allow Ouellet representatives to check the defective Product. The following must be attached to the defective product claim, otherwise the warranty may be invalidated at the sole discretion of Ouellet: a copy of the six (6) insulation and resistance test steps Measurement table (Figure 1) completed as per the Instruction Manual during installation of the Product; and the Owner’s original sales receipt for the Product or the invoice given to the Owner by the retailer/installer of the Product.

If the Product is deemed to be defective, Ouellet will take, at its discretion, one of the following corrective measures:

- a) Cover labour and materials costs to identify the source of the defect, prepare the floor to be repaired, carry out repair of the Product and return the floor to a similar state to how it was before repair (“Original Floor”). Given the natural ageing of floor covering materials, Ouellet does not guarantee a perfect color match of porcelain tiles, stone or any other floor covering needed for repair; or
- b) Reimburse the Owner a sum not exceeding the amount calculated by the following formula:

$$\frac{\text{Floor area repaired}}{\text{Total floor area}} \times \text{Initial price of the total floor area*} = \text{Amount refunded}$$

*The initial price of the total floor area is based on the labour and materials costs used for creation of the Original Floor, as proved by all applicable invoices presented by the Owner.

Limited Warranty limitations and exclusions

This Limited Warranty is void if any of the following apply:

- a) The Product was not installed according to the instructions in the Product Instruction Manual;
- b) The Product has been used for purposes other than domestic use;
- c) The Product was not installed according to applicable regulations at the place of installation, including, but not limited to, any required codes and permits;
- d) During installation of the Product, the six (6) insulation and resistance test steps were not performed and recorded in the measurement table (Figure 1) as per the Instruction Manual;
- e) Damage and/or failure due to incorrect use, negligence, incorrect settings used, modification and/or alteration of the Product;
- f) Product failure due to power supply failure and/or interruptions, or due to a power supply that is defective, incorrect, inadequate, or non-compliant with applicable regulations and standards.

Figure 1

Tableau de mesures - Apposer au tableau électrique <i>Measurement table - Place in electrical panel</i>	Résistance Resistance (Ω)	Isolation Insulation > 1MΩ
Résultats d'usine/Factory results	Ex. : 11.52	OK
1. Avant de briser sceau/Before breaking seal		
2. Après la pose du câble/After cable installation		
3. Avant l'enrobage du câble/Before embedding cable		
4. Après l'enrobage du câble/After embedding cable		
5. Après la pose finale du revêtement/After final surfacing		
6. Avant raccordement du système/Before wiring system		



Calora

European-Style Convector



OCEH
White

OCEM
Stainless Steel

OCEB
White



This efficient and perfectly silent natural convection heating system provides uniform room temperatures for increased comfort. The convector is available in three different heights compatible with all room types. It can be equipped with a built-in (TH models) or wall-mounted (OTH models) electronic thermostat that meets the highest performance standards. When combined with the wall-mounted thermostat, the convector may be installed on an exterior wall. Calora and its thermostats provide an ingenious heating system that maximizes both comfort and energy efficiency.

Features

Color

- Standard:

BL White

AM Almond

- Optional (10\$ upcharge and 5 days production lead time):

NL Semi-Gloss Black

CM Metallic Charcoal

BZ Bronze

AE Metallic Silver

AL Aluminum

SA Sand

Note: Due to the printing, the colors may vary from the actual colors.

Finish

- Standard: epoxy/polyester powder paint.
- Optional: stainless steel (only grilles are painted black).

Voltage

- 240/208V, 50/60 Hz, 1-phase.

Construction

- 20-gauge steel or 22-gauge stainless steel.
- Warm air outlet that directs the air to the centre of the room.
- Bar grilles prevent insertion of foreign objects; smooth-finish paint is washable and anti-yellowing.
- High-limit temperature control with automatic reset.

Heating element

- Quiet aluminum monoblock element.

Watt density

- OCEH: 850W/ft. (2800W/m)
- OCEM: 700W/ft. (2320W/m)
- OCEB: 500W/ft. (1700W/m)

Control

- Built-in electronic thermostat (TH models)
- Wall-mounted electronic thermostat (OTH models).

Installation

- 2 in. (51 mm) minimum clearance to floor.
- The convector's wall mounting bracket is connected to the power supply.
- Simply place the convector on the bracket to make it operational.

Warranty

- 5-year warranty against defects.
(The warranty is valid only if the heater is controlled by a proportional pulsing electronic thermostat with a cycle of 15 seconds maximum and the junction box must be fixed to the wall with the supplied anchor.)

Application

- Kitchen, living room, family room, bedroom, bay window, basement.

Models							
Watts	Volts	Product #		Price		Length	
		Non Programmable Built-In Thermostat	Non Programmable Wall-Mounted Thermostat	Standard Models	Stainless Steel	in.	m
Height 27" (685 mm) 850W/ft. (2800W/m)							
500/375	240/208	OCEH0500-TH	OCEH0500-OTH	522.00	640.00	10 5/8	270
1000/750	240/208	OCEH1000-TH	OCEH1000-OTH	579.00	711.00	16 1/2	418
1500/1125	240/208	OCEH1500-TH	OCEH1500-OTH	634.00	780.00	23	584
2000/1500	240/208	OCEH2000-TH	OCEH2000-OTH	703.00	866.00	28 1/8	714
2500/1875	240/208	OCEH2500-TH	OCEH2500-OTH	763.00	941.00	34	862
3000/2250	240/208	OCEH3000-TH	OCEH3000-OTH	820.00	1012.00	41 1/8	1044
Height 18 1/2" (470 mm) 700W/ft. (2320W/m)							
500/375	240/208	OCEM0500-TH	OCEM0500-OTH	506.00	620.00	13 1/2	344
1000/750	240/208	OCEM1000-TH	OCEM1000-OTH	557.00	683.00	19 7/16	492
1500/1125	240/208	OCEM1500-TH	OCEM1500-OTH	625.00	768.00	26 1/2	674
2000/1500	240/208	OCEM2000-TH	OCEM2000-OTH	689.00	848.00	34	862
2500/1875	240/208	OCEM2500-TH	OCEM2500-OTH	748.00	922.00	41 1/8	1044
3000/2250	240/208	OCEM3000-TH	OCEM3000-OTH	807.00	996.00	48 3/8	1229
Height 14" (356 mm) 500W/ft. (1700W/m)							
500/375	240/208	OCEB0500-TH	OCEB0500-OTH	534.00	655.00	19 7/16	492
1000/750	240/208	OCEB1000-TH	OCEB1000-OTH	590.00	725.00	26 1/2	674
1500/1125	240/208	OCEB1500-TH	OCEB1500-OTH	660.00	812.00	36 3/8	924
2000/1500	240/208	OCEB2000-TH	OCEB2000-OTH	719.00	886.00	46 7/16	1179
2500/1875	240/208	OCEB2500-TH	OCEB2500-OTH	778.00	960.00	62 3/16	1579
3000/2250	240/208	OCEB3000-TH	OCEB3000-OTH	838.00	1035.00	69 5/16	1760

Add «BL» for white, «AM» for almond and «SS» for stainless steel. For stainless steel models, only the grille are black painted.
 Warranty is valid only if the heater is controlled by a proportional electronic pulsing line thermostat with a cycle of 15 seconds maximum and the junction box must be fixed to the wall with the supplied anchor.

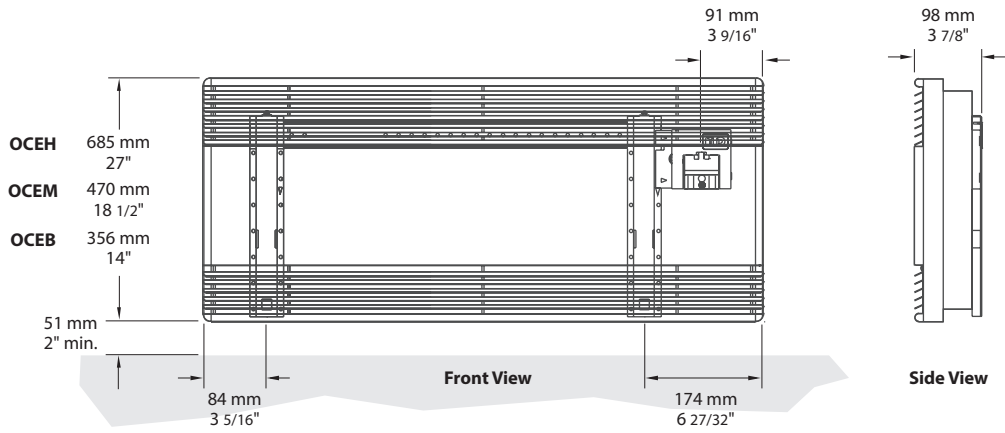



Espresso

European-Style Wall Heater



OVE-TM
White



OVE-T
White



OVE
Stainless Steel



Designed for areas with space restrictions and high heating requirements, the Espresso wall heater delivers instant warmth and ultra-quiet operation. Suitable for recessed or wall-mount installation in various configurations to meet your needs:

- without built-in thermostat for a wall control;
- with built-in thermostat (T models);
- with built-in thermostat and timer (TM models).

Features

Color

• Standard:

BL White	AM Almond
-----------------	------------------

• Optional (10\$ upcharge and 5 days production lead time):

NL Semi-Gloss Black	CM Metallic Charcoal	BZ Bronze
----------------------------	-----------------------------	------------------

AE Metallic Silver	AL Aluminum	SA Sand
---------------------------	--------------------	----------------

Note: Due to the printing, the colors may vary from the actual colors.

Finish

- Standard: epoxy/polyester powder paint.
- Optional: stainless steel (grilles and back of the heater are painted black).

Voltage

- 120V, 240/208V, 1-phase.

Construction

- 20-gauge steel or 22-gauge stainless steel.
- Outlet-grille efficiently distributes warm air throughout the heated area.
- Bar grilles prevent insertion of foreign objects; smooth-finish paint is washable and anti-yellowing.
- High-limit temperature control with automatic reset.

Fan

- Whisper-quiet squirrel-cage fan.
- Factory-lubricated motor.

Heating element

- Element provides instant heat.

Control

- Bulb thermostat (T and TM models).
- Mechanical timer in TM model (0-60 min).

Note: If an electronic wall-mounted thermostat is used, it must be compatible with forced-air heaters.

Installation

- 12 in. (306 mm) minimum clearance to floor.
- May be recessed or surface-mounted without adaptor in 2 in. X 3 in. stud partitions.
- Holes for fastening and convenient knock-outs allow for easy installation and connection (mounting screws included).

Warranty

- 5-year warranty against defects.

Application

- Bathroom, kitchen, family room, entrance way.

Models

Watts	Volts	Product #	Price	
			Standard Models	Stainless Steel
1500	120	OVE1502 ¹	433.00	555.00
1500	120	OVE1502-T	498.00	636.00
1500	120	OVE1502-TM	540.00	689.00
1500/1125	240/208	OVE1500 ¹	366.00	468.00
1500/1125	240/208	OVE1500-T	420.00	541.00
1500/1125	240/208	OVE1500-TM ²	457.00	584.00
1500/1125	240/208	OVE1500BL-TM ³	297.00	-

¹ Requires non pulsing wall-mounted thermostat.

² Price for standard "AM" almond color and base price for upcharge applicable on optional colors.

³ Price for standard "BL" white color.

Add «BL» for white, «AM» for almond, «SS» for stainless steel.

For almond models with -T or -TM the knobs are black.

For stainless steel models the grilles and the back of the heater are painted black.

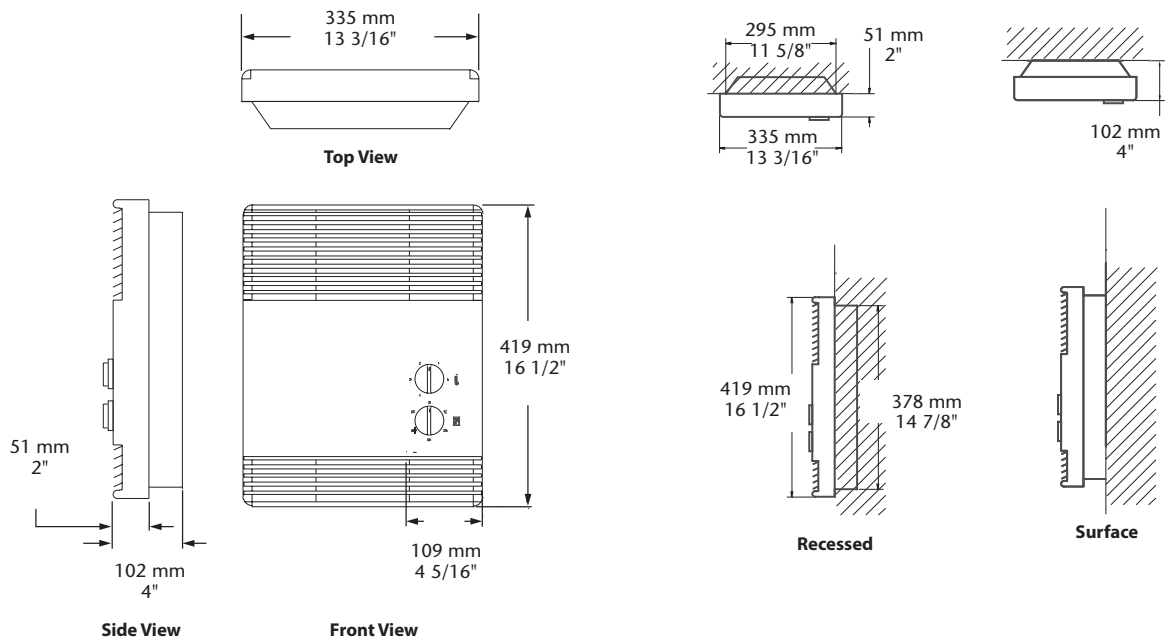



Morelli

Convection and Forced-Air Wall Heater



Surface
with Trim Sleeve

Surface

Recessed



The Morelli heater combines the quiet operation of convection heating and high power boost capabilities of fan heaters. Its digital control provides easy operation and precise temperature control. A cast aluminum front cover featuring the elegance of a Morelli design makes it the toast of any bathroom.

Features

Color

- Standard:



- Optional (10\$ upcharge and 5 days production lead time):

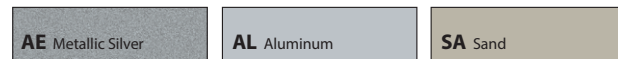
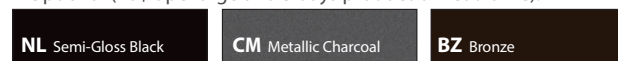

Note: Due to the printing, the colors may vary from the actual colors.

Finish

- Standard: epoxy/polyester powder paint.

Voltage

- 240V, 1-phase.

Construction

- Cast aluminum front cover.
- Steel bar grilles prevent the insertion of foreign objects; smooth-finish paint is washable and anti-yellowing.
- Automatic reset safety device.
- Built-in white LED night light.

Fan

- Whisper-quiet squirrel-cage fan.
- Factory-lubricated motor.

Heating element

- Element provides instant heat.

Control

- Built-in electronic digital thermostat/timer.
- Thermostat mode: pulse modulation: automatic convection to fan-forced switch-over at 1000W.
- Timer mode: 5-30 minutes full power fan-forced boost.

Installation

- 4 in. (102 mm) minimum clearance to floor.
- May be recessed in 2 in. X 3 in. stud partitions.
- May be surface-mounted without or with the optional casted trim sleeve.
- Mounting holes for ease of installation.
- Large wiring compartment.

Warranty

- 5-year warranty against defects.

Application

- Bathroom, kitchen, family room, entrance way.



Night light



Display module



Night light
and sensor

Morelli - Convection and Forced-Air Wall Heater

Model				
Watts	Volts	Product #	Price	
2000 ¹	240	OHY2000-TH ¹	773.00	

¹ BEWARE: Not available for 208V.
 Add «BL» for white, «AM» for almond.
 Electronic thermostat available in grey only.

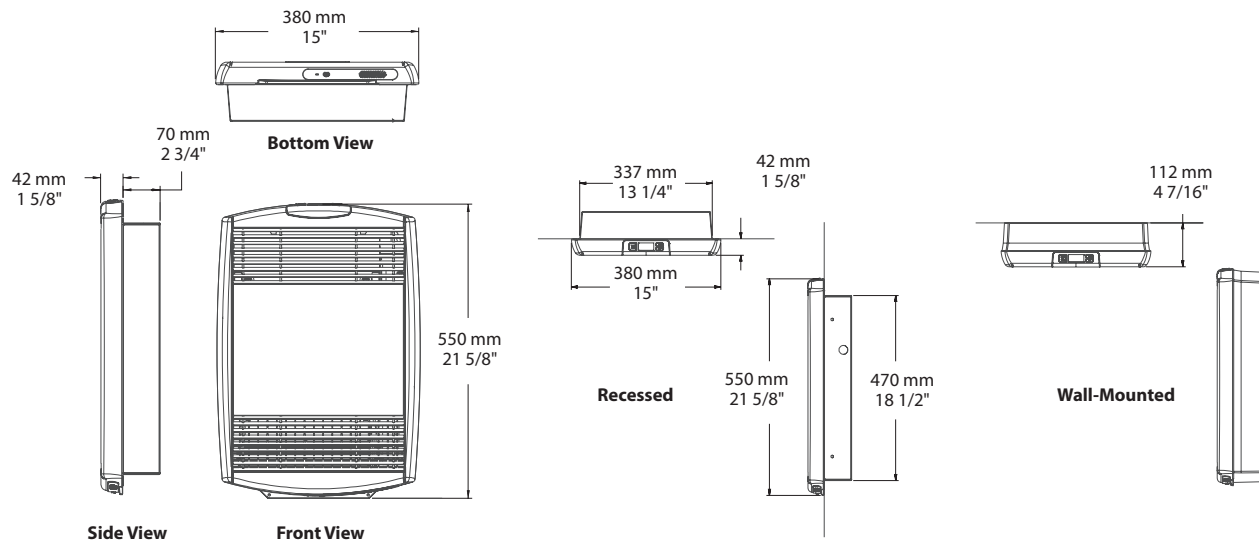

Viento

Compact Wall Heater



Surface

Recessed



The Viento wall heater has clean lines and rounded corners which match perfectly with any decor. Its compact size makes this heater perfect for areas with limited space. It can be installed recessed or on the wall surface with 4 different mounting positions, adapting to any installation requirement.

Features

Color

- Standard:



- Optional (10\$ upcharge and 5 days production lead time):

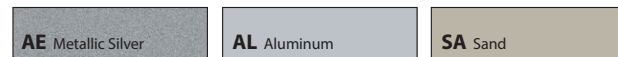
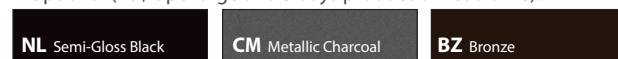

Note: Due to the printing, the colors may vary from the actual colors.

Finish

- Standard: epoxy/polyester powder paint.

Voltage

- 120V, 240/208V, 1-phase.

Construction

- 20-gauge steel cabinet.
- 22-gauge steel front cover.
- High-limit temperature control with automatic reset.

Fan

- Quiet fan operating.
- 500W to 1000W; 40 cfm fan and 1250W to 2000W; 80 cfm fan.
- Factory-lubricated motor.

Heating element

- Durable tubular heating element with fins.

Control

- Built-in thermostat available with a control knob.
- Note: If an electronic thermostat is used, it must be compatible with forced-air heaters.*

Installation

- Wall installation only.
- The air outlet should be installed at least 4 in. (102 mm) from flooring withstands temperature and 10 in. (254 mm) from linoleum flooring.
- Quick installation with recess box mounting holes.
- Large wiring compartment.
- May be recessed in 2 in. X 3 in. stud partitions.
- Surface mounting box available.
- Tight fit with V-shaped recess box.

Warranty

- 5-year warranty against defects.

Application

- Entrance way, kitchen, bathroom, family room, basement.

Viento - Compact Wall Heater

Models			
Watts	Volts	Product #	Price
500	120	OVS0502	271.00
1000	120	OVS1002	288.00
1500	120	OVS1502	314.00
500/375	240/208	OVS0500	266.00
1000/750	240/208	OVS1000	281.00
1500/1125	240/208	OVS1500	310.00
2000/1500	240/208	OVS2000	335.00

Options		
Product #	Price	Description
KIT-OVS-BS	65.00	Surface mounting box
KIT-OVS-TB6	57.00	Single-pole bi-metal thermostat kit with a control knob
KIT-OVS-TB26 ¹	70.00	Double-pole bi-metal thermostat kit with a control knob

¹ «Off» position.
Add «BL» for white, «AM» for almond.

Four mounting positions available. Pictures showing front panel. Directional vane air flow.

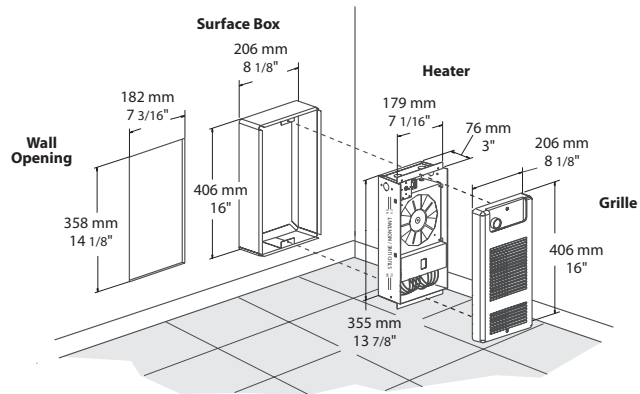
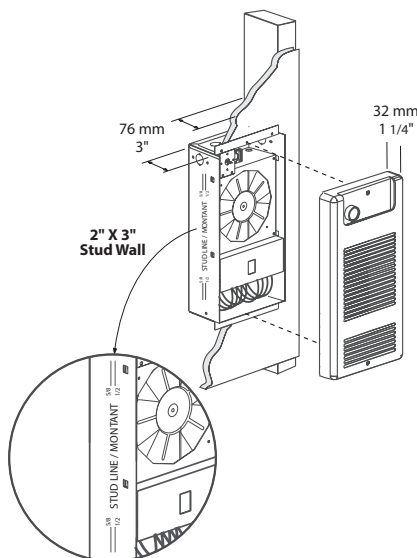
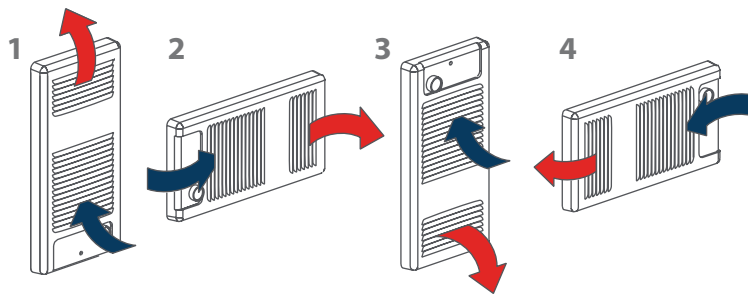

Electronic Thermostats for Heating Units



CSA-C828-13
Performance Standard
ICES-003 Standard Compliant

Programmable electronic thermostats



OTH3000P-A



OTH4000P-A

Non programmable electronic thermostats



OTH3000-A



OTH4000-A

Electronic thermostats read the room temperature up to 240 times per hour, enabling it to maintain a much more uniform temperature, within approximately ± 0.15 °C of the set temperature.

Superior comfort isn't the only reason to opt for electronic thermostats: they'll also save you money on your heating bill. Hydro-Québec estimates that electronic thermostats deliver savings up to 10% on annual heating costs over their mechanical counterparts.

You can save even more—up to 4.5% according to Hydro-Québec studies—by using programmable thermostats and setting them to lower the temperature by 3 °C at night and when you are at work.

Models

Product #	Price	Description	Watts	Volts
OTH3000-A	51.00	Non programmable electronic proportional pulsing thermostat	1380/2390/3000	120/208/240
OTH4000-A	60.00			
OTH3000P-A	76.00	Programmable electronic proportional pulsing thermostat	1380/2390/3000	120/208/240
OTH4000P-A	86.00			

Smart Controls for Heating Units

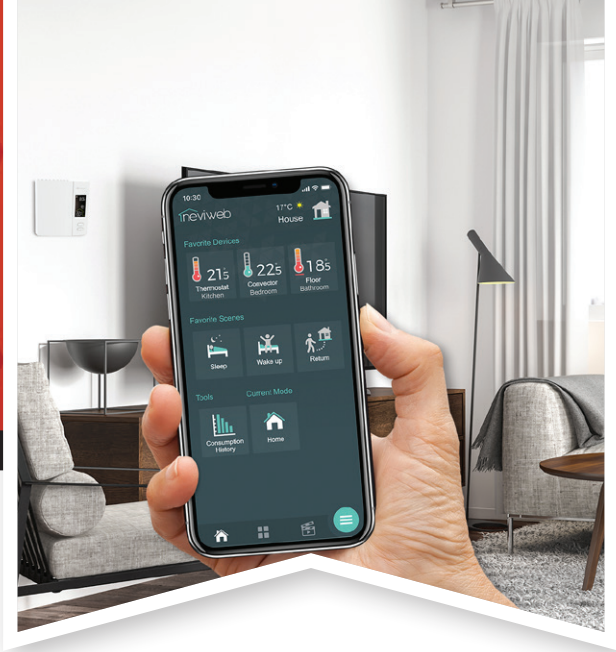

Zigbee



CSA-C828-13
Performance Standard

ICES-003 Standard Compliant

OTH4000 -ZB Series

Smart thermostat - Zigbee

The OTH4000 -ZB is compatible with the GT130 smart gateway. Among other features, it can be programmed (only through the Neviweb® platform) to allow individual temperatures to be set for six periods per day and for each day of the week. Daily and monthly usage can be monitored to help cut down on heating costs.



With great features like automation and scenes, smart thermostats are a smart choice for better comfort and to help you save on heating costs.

Automation enables interaction between activated products automatically according to a set program. For example, thermostats in the bedroom, bathroom and kitchen can all increase to 22°C at 6:15 a.m. on weekdays.

With scenes you can group actions together on your devices and enable them in just one click. For example, if you have a home gym, you can lower the temperature during your workout session for better comfort.

According to Hydro-Québec, you can save about 15% when you use programming functions and if you lower the temperature by 3°C during the night and when you're at work.

GT130 Series

Smart Gateway - Zigbee

The GT130 smart gateway provides remote access to all your Neviweb®-compatible products including your Zigbee smart thermostats with the Neviweb® app. The only requirement for the smart gateway is a broadband Internet connection and an open port on a router. Ideal for homes, condos and holiday homes.



Models

Product #	Price	Description	Watts	Volts
OTH4000-ZB	106.00	Smart thermostat - Zigbee	2000/3465/4000	120/208/240
GT130	122.00	Smart gateway that provides remote access to the OTH3600-GA-ZB and OTH4000-ZB	-	-

Heating Units Warranty

Momento products are guaranteed against all defects for one year following the date of purchase or extended warranty. The company's responsibility is limited to the replacement of defective parts. This warranty shall be limited to the actual equipment involved and does not cover installation or removal costs, travel time, or freight-related expenses.

Defects must be reported to Customer Service to obtain an authorization of repair or replacement. Repairs may be performed at the factory or any authorized repair center.

This warranty does not apply to damages, failure, or the results of an accident, alteration, misuse, abuse, incorrect installation, or operation from an incorrect power source.

Extended Warranty - Subject to the aforementioned conditions

3-year warranty against defects

Controls and Thermostats

5-year warranty against defects

Calora¹, Espresso, Morelli, Viento

25-year warranty on the heating cable

CAR, CAR-P

¹ The warranty is valid only if the heater is controlled by a proportional pulsing electronic thermostat with a cycle of 15 seconds maximum and the junction box must be fixed to the wall with the supplied anchor.

Terms and Conditions

Payment terms

Net 30 days.
2% - 10 days.

Shipping lead-time

Purchase order less than \$2500, shipping lead-time is 5 working days or less. For purchase order over \$2500, please contact customer service for our best shipping lead-time.

Returns

For returns of defective products, call Customer Service at 1 800 463-7043.
Merchandise returns (excess inventory) are subject to a restocking fee of 25%.

Any request for a return merchandise authorization must be sent to Customer Service. You must provide the purchase order number for each product purchased. Some fees may apply. Returned merchandise must be shipped "pre-paid." All the steps to follow are set out in the "Merchandise Returns" form sent out with the authorization number. This number must be visible on all product return packages. Products must arrive at the destination in good condition. Certain product series cannot be returned, if for example they are in special colors, are assembled with options not commonly ordered, are custom made, etc.

Shipping charges

Prepaid.

Minimum order

The minimum value of an order is \$25.

Specific Conditions

Account Opening

Complete and return this document by fax to 1 800 662-7801 or scan and email it to jean.bouissac@ouellet.com.

Billing address

Company name _____
Address _____
Email address _____
Telephone _____ Fax _____
Approximate amount of credit requested (\$) _____ (maximum amount)

Shipping address (if different) N/A

Address _____
Telephone _____ Fax _____

Key contacts

President/Owner _____
Sales VP or Mgr. _____
Procurement Mgr. _____
IT (computers) _____

Bank references

Institution name _____
Address _____
Contact person _____ Telephone _____

Institution name _____
Address _____
Contact person _____ Telephone _____

Credit references

DUNS # _____
Company name _____
Address _____
Contact person _____ Telephone _____

Company name _____
Address _____
Contact person _____ Telephone _____

